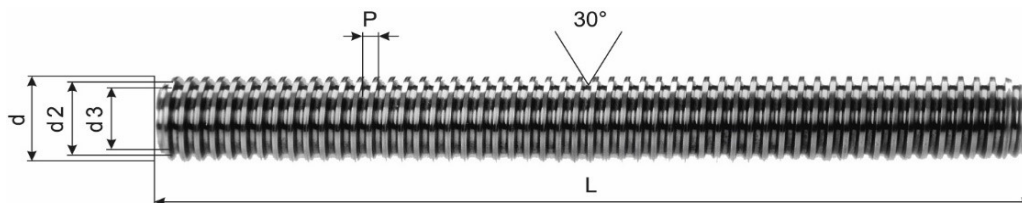

2203 Trapezgewinde-Spindel

L = 3'000 mm

Gewinde gerollt, Qualität 7e, DIN 103,
Einsatzstahl Ck15**Broche trapézoïdale**

L = 3'000 mm

Filetage roulé, qualité 7e, DIN 103,
acier de construction Ck15

Artikel article	Aussen-Ø/Steigung Ø-extérieur/pas d x P	Flanken-Ø Ø-flancs d 2		Kern-Ø Ø-intérieur d 3	Gewicht poid kg/m	Genauigkeit précision P/300 mm X/300 mm	
		minimum	maximum			µ	mm
2203-01030	TR 10 x 2	8.739	8.929	6.89	0.500	300	0.5
2203-10300	TR 10 x 3	8.191	8.415	5.84	0.446	300	0.5
2203-12300	TR 12 x 3	10.191	10.415	7.84	0.746	300	0.5
2203-14330	TR 14 x 3	12.191	12.415	9.84	0.940	300	0.5
2203-14300	TR 14 x 4	11.640	11.905	8.80	0.888	300	0.5
2203-16300	TR 16 x 4	13.640	13.905	10.80	1.208	50	0.1
2203-18300	TR 18 x 4	15.640	15.905	12.80	1.578	50	0.1
2203-20300	TR 20 x 4	17.640	17.905	14.80	2.000	50	0.1
2203-22300	TR 22 x 5	19.114	19.394	15.50	2.226	50	0.1
2203-24300	TR 24 x 5	21.094	21.394	17.50	2.720	50	0.1
2203-26300	TR 26 x 5	23.094	23.394	19.50	3.260	50	0.1
2203-28300	TR 28 x 5	25.094	25.394	21.50	3.850	50	0.1
2203-30300	TR 30 x 6	26.547	26.882	21.90	4.500	50	0.1
2203-32300	TR 32 x 6	28.547	28.882	23.90	5.180	50	0.1
2203-36300	TR 36 x 6	32.547	32.882	27.90	6.710	50	0.1
2203-40300	TR 40 x 7	36.020	36.375	30.50	8.000	50	0.1
2203-44300	TR 44 x 7	40.020	40.275	34.50	9.870	50	0.1
2203-48300	TR 48 x 8	43.468	43.868	37.80	11.950	100	0.1
2203-50300	TR 50 x 8	45.468	45.868	39.30	13.050	100	0.1
2203-60300	TR 60 x 9	54.935	55.360	48.15	17.980	200	0.3
2203-70300	TR 70 x 10	64.425	64.350	57.00	26.000	200	0.3

Andere Masse und Linksgewinde
auf Anfrage.Autre mesures et filetage à gauche
sur demande.

2206 Trapezgewinde-Spindel, mehrgängig

L = 3'000 mm

Gewinde gerollt, Qualität 7e, DIN 103,
Einsatzstahl Ck15

Broche trapézoïdale, filetage à plusieurs filets

L = 3'000 mm

Filetage roulé, qualité 7e, DIN 103,
acier de construction Ck15

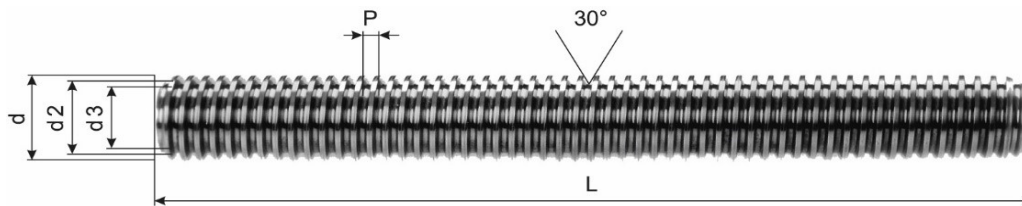

Artikel article	Aussen-Ø/Steigung Ø-extérieur/pas	Flanken-Ø Ø-flancs		Kern-Ø Ø-intérieur	Gewicht poid	Genauigkeit précision	
		d 2	d 3			P/300 mm	X/300 mm
	d x P	minimum	maximum	minimum	kg/m	µ	mm
2206-1006330	TR 10 x 6 P3	8.165	8.415	6.135	0.446	300	0.5
2206-1206330	TR 12 x 6 P3	10.165	10.415	8.135	0.746	300	0.5
2206-1209330	TR 12 x 9 P3	10.165	10.415	8.135	0.746	300	0.5
2206-1212330	TR 12 x 12 P3	10.165	10.415	8.135	0.746	300	0.5
2206-1218330	TR 12 x 18 P3	10.165	10.415	8.135	0.746	100	0.1
2206-1224330	TR 12 x 24 P3	10.165	10.415	8.135	0.746	100	0.1
2206-1406330	TR 14 x 6 P3	12.165	12.415	10.135	0.937	100	0.1
2206-1606330	TR 16 x 6 P3	14.165	14.415	12.135	1.208	100	0.1
2206-1608430	TR 16 x 8 P4	13.640	13.950	11.074	1.208	100	0.1
2206-1808430	TR 18 x 8 P4	15.640	15.950	13.074	1.578	100	0.1
2206-2008430	TR 20 x 8 P4	17.608	17.950	15.074	2.000	100	0.1
2206-2024430	TR 20 x 24 P4	17.608	17.950	15.074	2.000	100	0.1
2206-2210530	TR 22 x 10 P5	19.140	19.505	16.019	2.226	100	0.1
2206-2410530	TR 24 x 10 P5	21.058	21.394	18.019	2.720	100	0.1
2206-2610530	TR 26 x 10 P5	23.058	23.394	20.019	3.260	100	0.3
2206-2610532	TR 26 x 10 P5 L	23.058	23.394	20.019	3.260	100	0.3
2206-2810530	TR 28 x 10 P5	25.058	25.394	22.019	3.850	100	0.3
2206-2810532	TR 28 x 10 P5 L	25.058	25.394	22.019	3.850	100	0.3
2206-3012630	TR 30 x 12 P6	26.057	26.882	22.463	4.500	100	0.3
2206-3212630	TR 32 x 12 P6	28.057	26.882	24.463	5.180	100	0.3
2206-4014730	TR 40 x 14 P7	35.978	36.375	31.431	8.000	100	0.3

Andere Masse und Linksgewinde
auf Anfrage.

Autre mesures et filetage à gauche
sur demande.

2213**Trapezgewinde-Spindel**

L = 3'000 mm

Gewinde geschnitten, Qualität 7e, DIN 103,
rostfreier Stahl 1.4104/1.4305**Broche trapézoïdale**

L = 3'000 mm

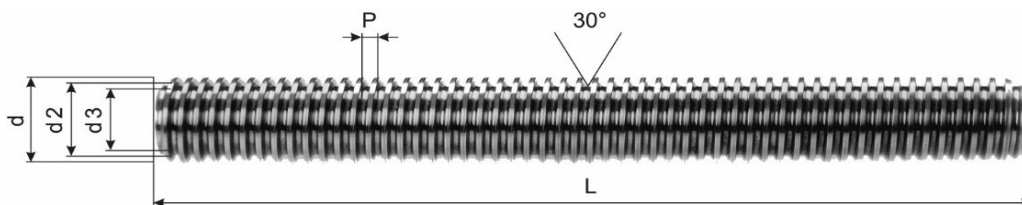
Filetage taillé, qualité 7e, DIN 103,
acier inoxydable 1.4104/1.4305

Artikel article	Aussen-Ø/Steigung Ø-extérieur/pas d x P	Flanken-Ø Ø-flancs d 2		Kern-Ø Ø-intérieur d 3 minimum	Gewicht poid kg/m
		minimum	maximum		
		2213-12300	TR 12 x 3		
2213-16300	TR 16 x 4	13.640	13.905	10.80	1.208
2213-20300	TR 20 x 4	17.640	17.905	14.80	2.000
2213-24300	TR 24 x 5	21.094	21.394	17.50	2.720
2213-30300	TR 30 x 6	26.547	26.882	21.90	4.500
2213-36300	TR 36 x 6	32.547	32.882	27.90	6.710
2213-40300	TR 40 x 7	36.020	36.375	30.50	8.000

Andere Masse und Linksgewinde
auf Anfrage.Autre mesures et filetage à gauche
sur demande.

2215 Trapezgewinde-Mutter
rund, Qualität 7H, DIN 103,
Automatenstahl 11SMnPb37, blank

Ecrou fileté trapézoïdal
rond, qualité 7H, DIN 103,
acier de décolletage 11SMnPb37, brut

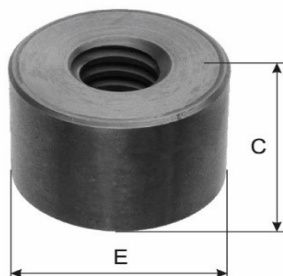

Artikel article	Gewinde filetage d x P	Aussen-Ø Ø-extérieur E	Höhe hauteur C	Kg/Stk kg/pce
2215-01020	TR 10 x 2	22	15	0.037
2215-00010	TR 10 x 3	22	15	0.037
2215-00012	TR 12 x 3	26	18	0.064
2215-01430	TR 14 x 3	30	21	0.096
2215-00014	TR 14 x 4	30	21	0.096
2215-00016	TR 16 x 4	36	24	0.192
2215-00018	TR 18 x 4	40	27	0.240
2215-00020	TR 20 x 4	45	30	0.315
2215-00022	TR 22 x 5	45	33	0.320
2215-00024	TR 24 x 5	50	36	0.450
2215-00026	TR 26 x 5	50	39	0.465
2215-00028	TR 28 x 5	60	42	0.780
2215-00030	TR 30 x 6	60	45	0.800
2215-00032	TR 32 x 6	60	48	0.860
2215-00036	TR 36 x 6	75	54	1.520
2215-00040	TR 40 x 7	80	60	1.892
2215-00044	TR 44 x 7	80	66	2.040
2215-00048	TR 48 x 8	90	72	2.600
2215-00050	TR 50 x 8	90	75	2.775
2215-00060	TR 60 x 9	100	90	3.865
2215-00070	TR 70 x 10	110	105	5.115

Andere Masse und Linksgewinde
auf Anfrage.

Autre mesures et filetage à gauche
sur demande.

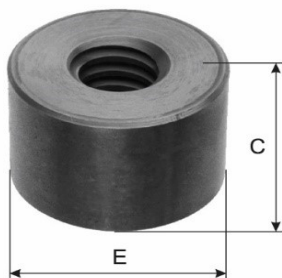
2218 Trapezgewinde-Mutterrund, Qualität 7H, DIN 103,
Bronze 50**Ecrou fileté trapézoïdal**rond, qualité 7H, DIN 103,
bronze 50

Artikel article	Gewinde filetage d x P	Aussen-Ø Ø-extérieur E	Höhe hauteur C	Kg/Stk kg/pce
2218-01020	TR 10 x 2	22	20	0.054
2218-00010	TR 10 x 3	22	20	0.056
2218-00012	TR 12 x 3	26	24	0.092
2218-01430	TR 14 x 3	30	28	0.108
2218-00014	TR 14 x 4	30	28	0.108
2218-00016	TR 16 x 4	36	32	0.240
2218-00018	TR 18 x 4	40	36	0.332
2218-00020	TR 20 x 4	45	40	0.468
2218-00022	TR 22 x 5	45	44	0.498
2218-00024	TR 24 x 5	50	48	0.670
2218-00026	TR 26 x 5	50	52	0.690
2218-00028	TR 28 x 5	60	56	1.134
2218-00030	TR 30 x 6	60	60	1.182
2218-00032	TR 32 x 6	60	64	1.202
2218-00036	TR 36 x 6	75	72	2.252
2218-00040	TR 40 x 7	80	80	2.794
2218-00044	TR 44 x 7	80	88	2.872
2218-00048	TR 48 x 8	90	96	3.984
2218-00050	TR 50 x 8	90	100	4.120
2218-00060	TR 60 x 9	100	120	5.678
2218-00070	TR 70 x 10	110	140	8.205

Andere Masse und Linksgewinde
auf Anfrage.Autre mesures et filetage à gauche
sur demande.

2219

Flanschmutter

rund, Qualität 7H, DIN 103,
Bronze 50



Ecrou à bride

rond, qualité 7H, DIN 103,
bronze 50

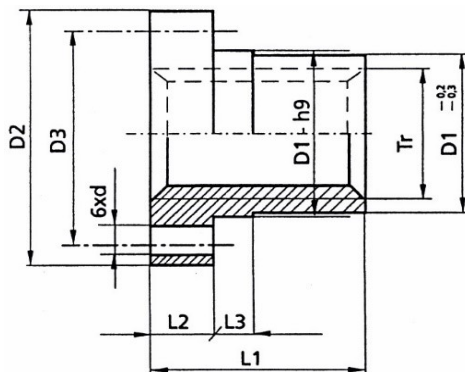

Artikel article	Gewinde filetage d x P	für Gewinde pour filetage									Kg/Stk kg/pce
		D1	D2	D3	d	L1	L2	L3			
2219-01020	TR 10 x 2	25	42	34	5	M 4	25	10	6	0.160	
2219-00010	TR 10 x 3	25	42	34	5	M 4	25	10	6	0.160	
2219-00012	TR 12 x 3	28	48	38	6	M 5	35	12	8	0.270	
2219-01430	TR 14 x 3	28	48	38	6	M 5	35	12	8	0.260	
2219-00014	TR 14 x 4	28	48	38	6	M 5	35	12	8	0.260	
2219-00016	TR 16 x 4	28	48	38	6	M 5	35	12	8	0.240	
2219-00018	TR 18 x 4	28	48	38	6	M 5	35	12	8	0.220	
2219-00020	TR 20 x 4	32	55	45	7	M 6	44	12	8	0.370	
2219-00022	TR 22 x 5	32	55	45	7	M 6	44	12	8	0.330	
2219-00024	TR 24 x 5	32	55	45	7	M 6	44	12	8	0.300	
2219-00026	TR 26 x 5	38	62	50	7	M 6	46	14	8	0.480	
2219-00028	TR 28 x 5	38	62	50	7	M 6	46	14	8	0.450	
2219-00030	TR 30 x 6	38	62	50	7	M 6	46	14	8	0.420	
2219-00032	TR 32 x 6	45	70	58	7	M 6	54	16	10	0.710	
2219-00036	TR 36 x 6	45	70	58	7	M 6	54	16	10	0.610	
2219-00040	TR 40 x 7	63	95	78	9	M 8	66	16	12	1.630	
2219-00044	TR 44 x 7	63	95	78	9	M 8	66	16	12	1.530	
2219-00048	TR 48 x 8	72	110	90	11	M 10	75	18	14	2.430	
2219-00050	TR 50 x 8	72	110	90	11	M 10	75	18	14	2.310	
2219-00060	TR 60 x 9	88	130	110	13	M 12	90	20	16	4.000	

Andere Masse und Linksgewinde
auf Anfrage.

Autre mesures et filetage à gauche
sur demande.

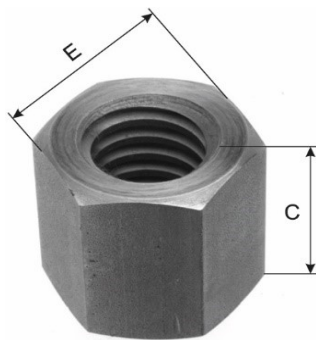
2220**Trapezgewinde-Mutter**6-kant, Qualität 7H, DIN 103,
Automatenstahl 11SMnPb37, blank**Ecrou fileté trapézoïdal**rond, qualité 7H, DIN 103,
acier de décolletage 11SMnPb37, brut

Artikel article	Gewinde filetage d x P	Schlüsselweite ouverture de clé E	Höhe hauteur C	Kg/Stk kg/pce
2220-01020	TR 10 x 2	17	15	0.022
2220-00010	TR 10 x 3	17	15	0.022
2220-00012	TR 12 x 3	19	18	0.033
2220-01430	TR 14 x 3	22	21	0.046
2220-00014	TR 14 x 4	22	21	0.046
2220-00016	TR 16 x 4	27	24	0.090
2220-00018	TR 18 x 4	27	27	0.095
2220-00020	TR 20 x 4	30	30	0.123
2220-00022	TR 22 x 5	30	33	0.135
2220-00024	TR 24 x 5	36	36	0.213
2220-00026	TR 26 x 5	36	39	0.225
2220-00028	TR 28 x 5	41	42	0.310
2220-00030	TR 30 x 6	46	45	0.447
2220-00032	TR 32 x 6	46	48	0.455
2220-00036	TR 36 x 6	55	54	0.752
2220-00040	TR 40 x 7	65	60	1.250
2220-00044	TR 44 x 7	65	66	1.320
2220-00048	TR 48 x 8	75	72	1.820
2220-00050	TR 50 x 8	75	75	1.895
2220-00060	TR 60 x 9	90	90	3.285
2220-00070	TR 70 x 10	90	105	3.390

Andere Masse und Linksgewinde
auf Anfrage.Autre mesures et filetage à gauche
sur demande.

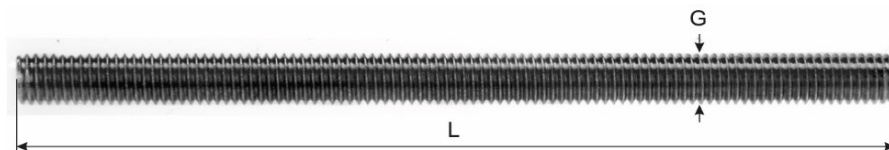
2234 Gewindestange, metrisch feinGewinde ISO, gerollt,
Qualität 4.8-5.6, blank**Tige filetée, métrique fin**Filetage ISO, roulé,
qualité 4.8-5.6, brut

Artikel article	Gewinde G filetage G	Länge L longueur L	Kg/Stk kg/pce
2234-08100	MF 8 x 1.00	1'000	0.315
2234-10100	MF 10 x 1.00	1'000	0.518
2234-10125	MF 10 x 1.25	1'000	0.504
2234-12100	MF 12 x 1.00	1'000	0.762
2234-12125	MF 12 x 1.25	1'000	0.754
2234-12150	MF 12 x 1.50	1'000	0.722
2234-16150	MF 16 x 1.50	1'000	1.352
2234-20100	MF 20 x 1.00	1'000	2.297
2234-20150	MF 20 x 1.50	1'000	2.182
2234-20200	MF 20 x 2.00	1'000	2.115
2234-24150	MF 24 x 1.50	1'000	3.261
2234-24200	MF 24 x 2.00	1'000	3.182
2234-30150	MF 30 x 1.50	1'000	5.180
2234-30200	MF 30 x 2.00	1'000	5.062

Andere Längen und Stahlqualitäten
auf Anfrage.Autres longueurs et qualités d'acier
sur demande.

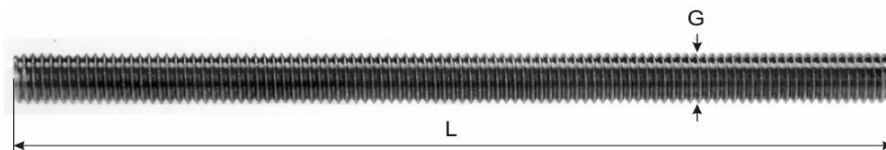
2236**Gewindestange**Gewinde ISO, gerollt,
Qualität 4.6, verzinkt**Tige filetée**Filetage ISO, roulé,
qualité 4.6, zinguée

Artikel article	Gewinde G filetage G	Länge L longueur L	Kg/Stk kg/pce
2236-03100	M 3	1'000	0.042
2236-04100	M 4	1'000	0.082
2236-05100	M 5	1'000	0.118
2236-06100	M 6	1'000	0.171
2236-06200	M 6	2'000	0.344
2236-08100	M 8	1'000	0.319
2236-08200	M 8	2'000	0.640
2236-10100	M 10	1'000	0.498
2236-10200	M 10	2'000	1.002
2236-12100	M 12	1'000	0.717
2236-12200	M 12	2'000	1.442
2236-14100	M 14	1'000	0.985
2236-14200	M 14	2'000	1.983
2236-16100	M 16	1'000	1.334
2236-16200	M 16	2'000	2.684
2236-18100	M 18	1'000	1.672
2236-18200	M 18	2'000	3.360
2236-20100	M 20	1'000	2.070
2236-20200	M 20	2'000	4.165
2236-22100	M 22	1'000	2.563
2236-24100	M 24	1'000	3.003
2236-27100	M 27	1'000	3.896
2236-30100	M 30	1'000	4.772
2236-33100	M 33	1'000	5.947
2236-36100	M 36	1'000	6.979
2236-39100	M 39	1'000	8.408

Andere Längen und Stahlqualitäten
auf Anfrage.Autres longueurs et qualités d'acier
sur demande.

2238 Treppenschraube
Sechskantkopf,
mit Sechskantmutter und U-Scheiben,
verzinkt

Boulon d'escalier
à tête 6-pans,
avec écrou 6-pans et rondelles,
zingué

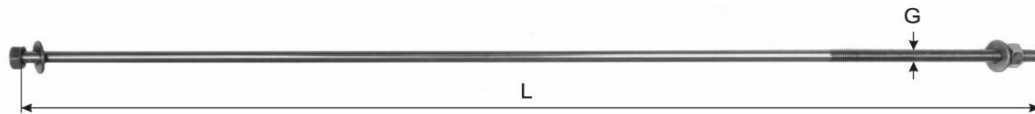

Bestell-Nr
No de commande

	L	G	
2238-00700	700	M 10x140	1
2238-00800	800	M 10x140	1
2238-00900	900	M 10x140	1
2238-01000	1'000	M 10x140	1
2238-01100	1'100	M 10x140	1
2238-01200	1'200	M 10x140	1
2238-01300	1'300	M 10x140	1

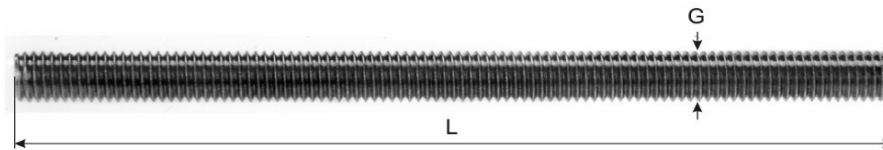
2239**Gewindestange**Gewinde ISO, gerollt,
rostfreier Stahl A2**Tige filetée**Filetage ISO, roulé,
acier inoxydable A2

Artikel article	Gewinde G filetage G	Länge L longueur L	Kg/Stk kg/pce
2239-03100	M 3	1'000	0.043
2239-04100	M 4	1'000	0.078
2239-05100	M 5	1'000	0.124
2239-06100	M 6	1'000	0.177
2239-08100	M 8	1'000	0.320
2239-10100	M 10	1'000	0.503
2239-12100	M 12	1'000	0.729
2239-14100	M 14	1'000	1.005
2239-16100	M 16	1'000	1.341
2239-20100	M 20	1'000	2.100
2239-24100	M 24	1'000	3.011

2240 Kropfschraube Metallgewinde

mit runden Schlitzmuttern
und U-Scheiben,
verzinkt

Boulon d'escalier vis à métal

avec écrous rond à rainures
et rondelles,
zingué

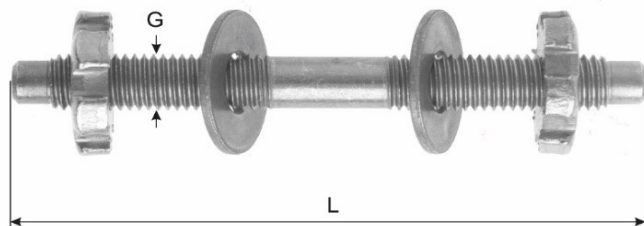

Bestell-Nr
No de commande

2240-00100
2240-00120
2240-00140

L	G	
100	M 10x35	25
120	M 10x35	25
140	M 10x35	25

2242 Kropfschraube Holzgewinde

mit runder Schlitzmutter
und U-Scheibe,
verzinkt

Boulon d'escalier vis à bois

avec écrou rond à rainure
et rondelle,
zingué

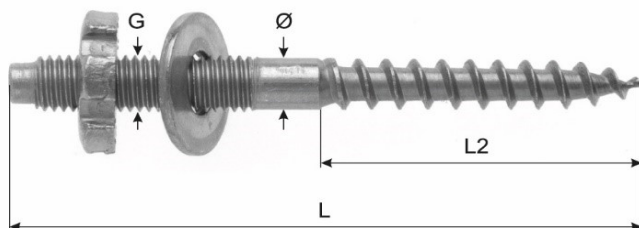

Bestell-Nr
No de commande

2242-08080
2242-10100
2242-10120

L	Ø	L2	G	
80	8	35	M 8x30	25
100	10	45	M 10x35	25
120	10	45	M 10x45	25

2244 Schlitzmutter

zu 2240-2242,
verzinkt

Écrou à rainures

pour 2240-2242,
zingué

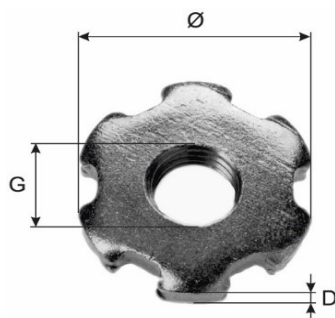

Bestell-Nr
No de commande

2244-00000
2244-00008

Ø	D	G	
25	6	M 10	100
22	5	M 8	100